

# R2DBEAM150

---

150w Pure Beam Moving Head



## User Manual

# 1 SAFETY INSTRUCTIONS



## CAUTION

Becareful with your operations. With a dangerous voltage you can suffer a dangerous electric shock when touching wires!

This device has left the factory in perfect condition. In order to maintain this condition and to ensure a safe operation, it is absolutely necessary for the user to follow the safety instructions and warning notes written in this user manual.



## IMPORTANT

Damages caused by the disregard of this user manual are not subject to warranty. The dealer will not accept liability for any resulting defects or problems.

If the device has been exposed to temperature changes due to environmental changes, do not switch it on immediately. The arising condensation could damage the device.

Leave the device switched off until it has reached room temperature.

This device falls under protection-class I. Therefore it is essential that the device be earthed.

The electric connection must carry out by qualified person.

The device shall only be used with rated voltage and frequency.

Make sure that the available voltage is not higher than stated at the end of this manual.

Make sure the power cord is never crimped or damaged by sharp edges. If this would be the case, replacement of the cable must be done by an authorized dealer.

Always disconnect from the mains, when the device is not in use or before cleaning it. Only handle the power cord by the plug. Never pull out the plug by tugging the power cord.

During initial start-up some smoke or smell or smell may arise. This is a normal process and does not necessarily mean that the device is defective, it should decrease gradually.

Please don't project the beam onto combustible substances.

Fixtures cannot be installed on combustible substances, keep more than 50cm distance with wall for smooth air flow, so there should be no shelter for fans and ventilation for heat radiation.

If the external flexible cable or cord of this luminaire is damaged, it shall be exclusively replaced by the manufacturer or his service agent or a similar qualified person in order to avoid a hazard.

## 2 UNPACKING

Thank you for choosing our LED 150W moving head light. For your own safety, please read this manual before installing the device. This manual covers the important information on installation and applications. Please install and operate the fixture with following instructions. Meanwhile, please keep this manual well for future needs.

The LED 150W is made of a new type of high temperature strength of engineering plastic and cast aluminum casing with nice outlook. The fixture is designed and manufactured strictly following CE standards, complying with international standard DMX512 protocol. It's available independently controlled and linkable with each other for operation. And it is applicable for large-scale live performances, theater, studio, nightclubs and discos.

The 150W Moving head light which features high brightness and stability. Please carefully unpack it when you receive the fixture and check whether it is damaged during the transportation. And please check whether the following items are included inside the box:

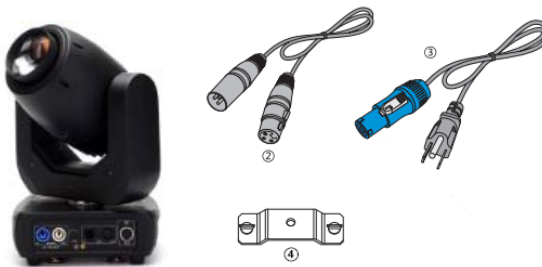

⑤

①	<b>Moving Head</b>	1PC
②	<b>Signal Cable</b>	1PC
③	<b>Power Cable</b>	1PC
④	<b>Omega Clamp</b>	1PC
⑤	<b>User Manual</b>	1PC

# 3

## **FEATURES & SPECIFICATIONS**

### **Features**

- 150W High Output White LED
- 50,000 hours lifespan and low power consumption
- Beam Angle 3°, Outstanding sharp BEAM effect and remarkable wash effect with pure color mixing and focus Function
- High light output, 18690LUX@5M at White light
- Temperature protect function, when the internal temperature is up to 40° and then the fans begin to work, when the internal temperature is up to 70° and the brightness reduce half.
- 1 Color Wheel: 11 colors +white, rotation with variable direction and speed
- Color fine tuning, color split
- 1 static Gobo Wheel: 14 gobos +white, shaking
- Prism: 16-facet Prism, bi-directionally rotatable at variable speeds
- High speed strobe effect with 1-25 flashers per second
- Internal program available
- 15 DMX Channels USITT DMX-512
- DMX 512, master-slave and sound activated controllable or auto operation
- Specific computer control software as optional
- Colorful LCD display
- Efficient low noise fan cooling system
- POWERCON IN/OUT
- 3-pin XLR connectors IN/OUT
- Two 1/4 turn fastening Omega Clamps
- IP 20 protection rating

### **Specifications**

Input Voltage: AC90-260V 50/60Hz

Light Source: 150W High Output White LED

Control Signal: DMX 512, master-slave and sound activated or auto operation

Control Channel: 15 DMX Channels USITT DMX-512

Power Consumption: 250W

Dimensions: 270(D)\*270(W)\*470(H)mm

Packing Dimensions: 345(D)\*275(W)\*520(H)mm

Net Weight: 12.5kg, Gross Weight: 14.0kg



## 4 PHOTOMETRIC DATA

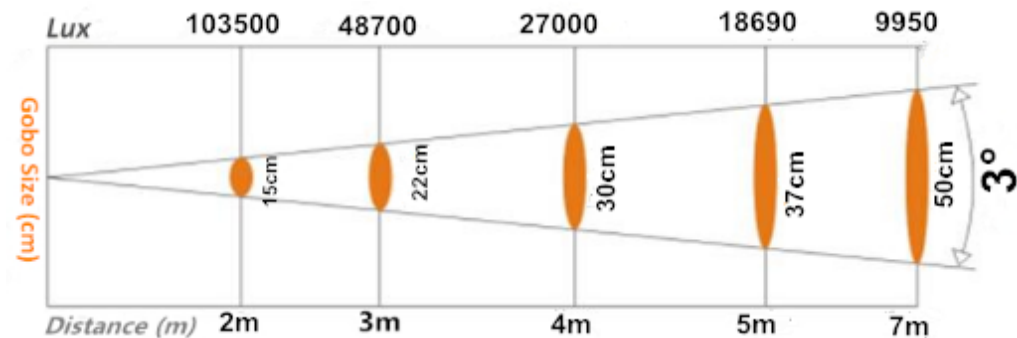

## **5** *OPERATION INSTRUCTIONS*

- The moving head is for beam effect for on-site decoration purpose.
- Don't turn on the fixture if it's been through severe temperature difference like after transportation because it might damage the light due to the environment changes. So make sure to operate the fixture until it is in normal temperature.
- This light should be keep away from strong shaking during any transportation or movement.
- Don't pull up the light by only the head, or it might cause damages to the mechanical parts.
- Don't expose the fixture in overheat, moisture or environment with too much dust when installing it. And don't lay any power cables on the floor. Or it might cause electronics shock to the people.
- Make sure the installation place is in good safety condition before installing the fixture.
- Make sure to put the safety chain and check whether the screws are screwed properly when installing the fixture.
- Make sure the lens are in good condition. It's recommended to replace the units if there are any damages or severe scratch.
- Make sure the fixture is operated by qualified personnel who know the fixture before using.
- Keep the original packages if any second shipments is needed.
- Don't try to change the fixtures without any instruction by the manufacturer or the appointed repairing agencies.
- It is not in warranty range if there are any malfunctions from not following the user manual to operate or any illegal operation, like shock short circuit, electronic shock, lamp broke, etc.

## **6** *INSTALLATIONS*

**Cautions:** For added protection mount the fixtures in areas outside walking paths, seating areas, or in areas were the fixture might be reached by unauthorized personnel.

Before mounting the fixture to any surface, make sure that the installation area can hold a minimum point load of 10 times the device's weight.

Fixture installation must always be secured with a secondary safety attachment, such as an appropriate safety cable.

Never stand directly below the device when mounting, removing, or servicing the fixture.

From a ceiling, or set on a flat level surface (see illustration below). Be sure this fixture is kept at least 0.5m (1.5ft) away from any flammable materials (decoration etc.).

Always use and install the supplied safety cable as a safety measure to prevent accidental damage and/or injury in the event the clamp fails.

**Mounting points:** Overhead mounting requires extensive experience, including amongst others calculating working load limits, a fine knowledge of the installation material being used, and periodic safety inspection of all installation material and the fixture. If you lack these qualifications, do not attempt the installation yourself. Improper installation can result in bodily injury.

Be sure to complete all rigging and installation procedures before connecting the main power cord to the appropriate wall outlet.

**Clamp Mounting:** The LED Moving Head provides a unique mounting bracket assembly that integrates the bottom of the base, and the safety cable rigging point in one unit (see the illustration below). When mounting this fixture to truss be sure to secure an appropriately rated clamp to the included omega bracket using a M10 screw fitted through the center hole of the "omega bracket". As an added safety measure be sure to attach at least one properly rated safety cable to the fixture using one of the safety cable rigging points integrated in the base assembly.

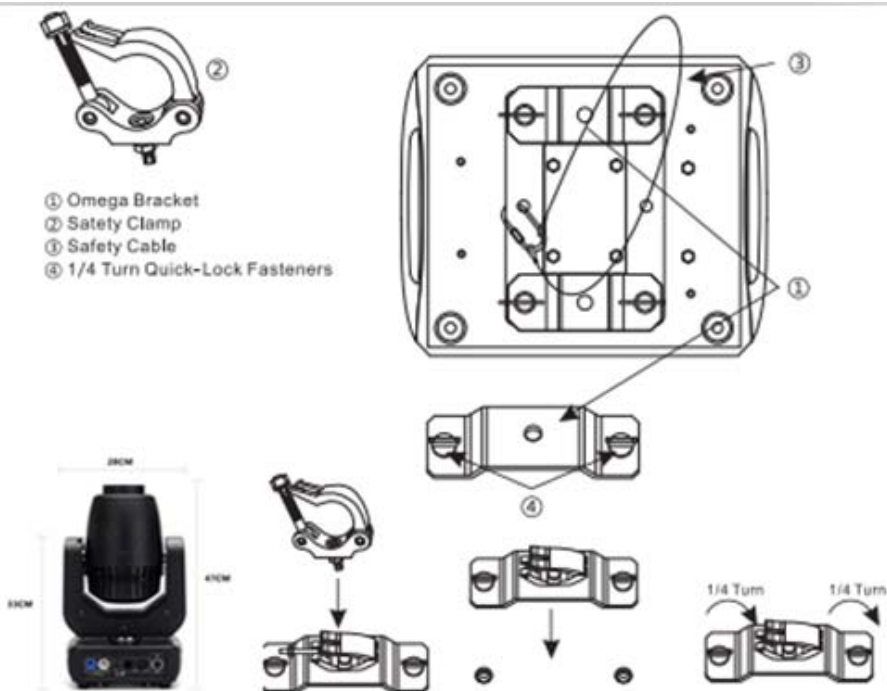

Regardless of the rigging option you choose for your LED Moving Head, always be sure to secure your fixture with a safety cable. The fixture provides a built-in rigging point for a safety cable on the hanging bracket as illustrated above. Be sure to only use the designated rigging point for the safety cable and never secure a safety cable to a carrying handle.

## **7** ***DMX-512 CONTROL CONNECTIONS***

Connect the provided XLR cable to the female 3-pin XLR output of your controller and the other side to the male 3-pin XLR input of the moving head. You can chain multiple moving head together through serial linking. The cable needed should be two core, screened cable with XLR input and output connectors. Please refer to the diagram below.



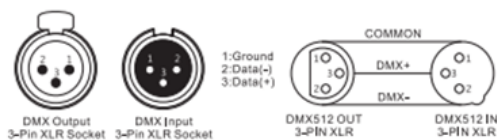

For installations where the DMX cable has to run a long distance or is in an electrically noisy environment, such as in a discotheque, it is recommended to use a DMX terminator. This helps in preventing corruption of the digital control signal by electrical noise. The DMX terminator is simply an XLR plug with a 120 Ω resistor connected between pins 2 and 3, which is then plugged into the output XLR socket of the last fixture in the chain. Please see illustrations

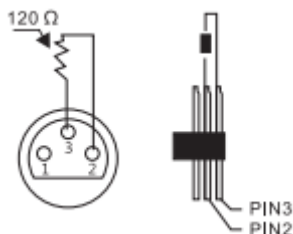

below.

## 8 MENU OPERATIONS

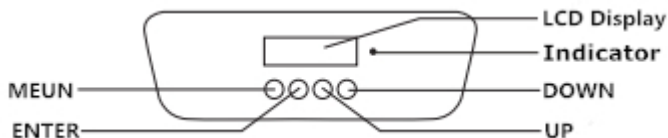

### MENU

Address Set → [Set Address Numbers]

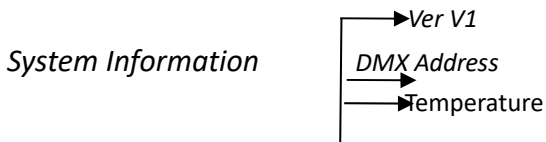
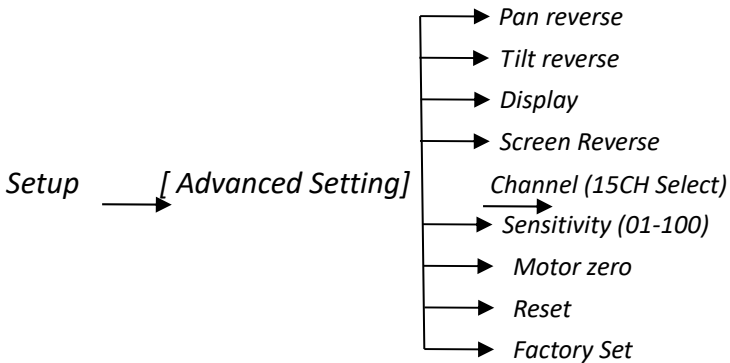
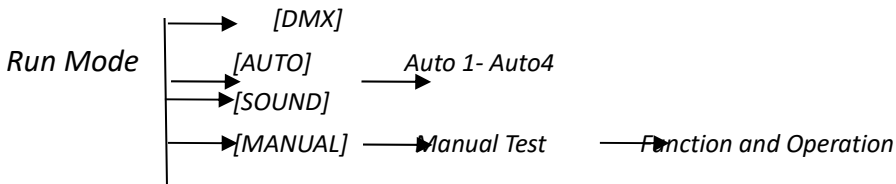

## 9 DMX CHANNELS

### 15channel mode sheet

15CH	Function	Channel Value	Discription
CH1	Pan	0-255	0-540°
CH2	Pan fine	0-255	Pan Fine
CH3	Tilt	0-255	0-270°
CH4	Tilt Fine	0-255	Tilt Fine
CH5	X, Y speed	0-255	From fast to slow

CH6	LED Dimmer	0-255	From dark to bright
CH7	LED Strobe	0-7	No function
		8-250	Strobe from fast to slow
		251-255	No function
CH8	11 color + White	0-9	White Lighting
		10-19	Color 1
		20-29	Color 2
		30-39	Color 3
		40-49	Color 4
		50-59	Color 5
		60-69	Color 6
		70-79	Color 7
		80-89	Color 8
		90-99	Color 9
		100-109	Color 10
		110-119	Color 11
		120-187	CW from slow to fast
188-255	CCW from slow to fast		
CH9	Color effect	0-10	No function
		11-209	Color fine tuning
		210-255	Color shake from fast to slow
CH10	14 Static Gobos +White	0-3	Open
		4-7	Gobo 1
		8-11	Gobo 2
		12-15	Gobo 3
		16-19	Gobo 4
		20-23	Gobo 5
		24-27	Gobo 6
		28-31	Gobo 7
		32-35	Gobo 8

		36-39	Gobo 9
		40-43	Gobo 10
		44-47	Gobo 11
		48-51	Gobo 12
		52-55	Gobo 13
		56-59	Gobo 14
		60-63	Gobo 14 shake speed from slow to fast
		64-67	Gobo 13 shake speed from slow to fast
		68-71	Gobo 12 shake speed from slow to fast
		72-75	Gobo 11 shake speed from slow to fast
		76-79	Gobo 10 shake speed from slow to fast
		80-83	Gobo 9 shake speed from slow to fast
		84-87	Gobo 8 shake speed from slow to fast
		88-91	Gobo 7 shake speed from slow to fast
		92-95	Gobo 6 shake speed from slow to fast
		96-99	Gobo 5 shake speed from slow to fast
		100-103	Gobo 4 shake speed from slow to fast
		104-107	Gobo 3 shake speed from slow to fast
		108-111	Gobo 2 shake speed from slow to fast
		112-115	Gobo 1 shake speed from slow to fast
		116-185	Gobo Rotate CW slow to fast
		186-255	Gobo Rotate CCW slow to fast
CH11	Focus	0-255	Gobo hazy to clear
CH12	Prism	0-63	Open
		64-255	Prism In
CH13	Prism Rotation	0-15	Stop
		16-135	Rotate CW slow > fast
		136-255	Rotate CCW slow > fast
CH14	self-setting	0-7	No action
	Program	8-131	Auto mode

		132-255	Sound mode
CH15	Reset	0-249	No function
		250-253	Reset
		254-255	No function

## **10** MAINTENANCE AND CLEANING

The following points have to be considered during the inspection:

- 1) All screws for installing the devices or parts of the device have to be tightly connected and must not be corroded.
- 2) There must not be any deformations on the housing, color lenses, fixations and installation spots (ceiling, suspension, trussing).
- 3) Mechanically moved parts must not show any traces of wearing and must not rotate with unbalances.
- 4) The electric power supply cables must not show any damage, material fatigue or sediments.

Further instructions depending on the installation spot and usage have to be adhered by a skilled installer and any safety problems have to be removed.



### **CAUTION**

Disconnect from mains before starting maintenance operation.



In order to make the lights in good condition and extend the life time, we suggest a regular cleaning to the lights.

- 1) Clean the inside and outside lens each week to avoid the weakness of the lights due to accumulation of dust.
- 2) Clean the fan each week.
- 3) A detailed electric check by approved electrical engineer each three month, make sure that the circuit contacts are in good condition, prevent the poor contact of circuit from overheating.

We recommend a frequent cleaning of the device. Please use a moist, lint-free cloth.

Never use alcohol solvents.

There are no serviceable parts inside the device. Please refer to the instructions under "Installation instructions".

Should you need any spare parts, please order genuine parts from your local dealer.



