

PANEL150TW

Studio LED Panel

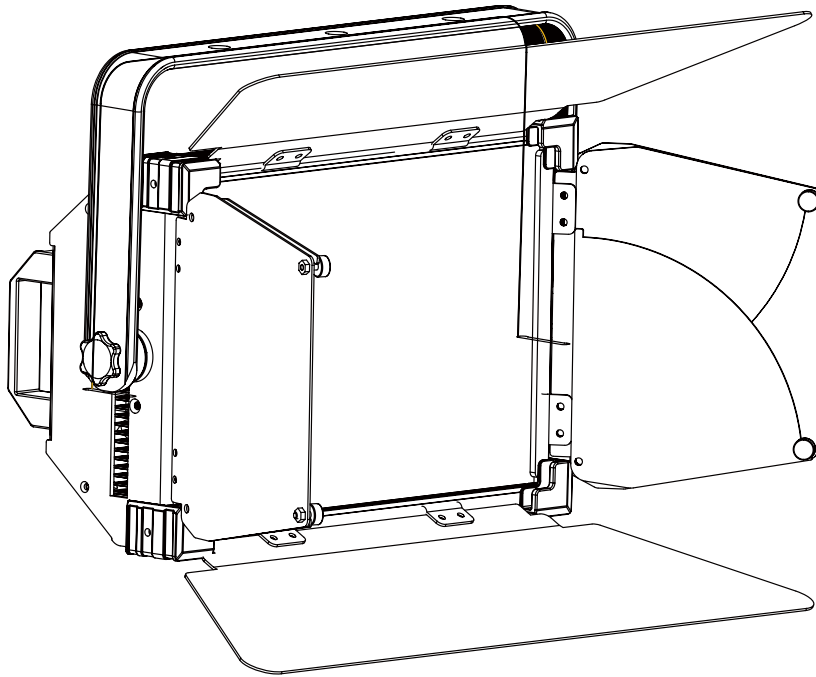

V1.1 SW2.4

USER MANUAL

- Be sure to read the USER MANUAL carefully before using this product.
- Be sure to keep the USER MANUAL properly for future needs.
- Use this product correctly when you can fully understand the User Manual

Table of contents

Caution!	3
Introduction	3
Safety instructions	3
Installation	4
Read 'Safety information' before installing the fixture.....	4
Fastening the fixture to a flat surface.....	4
Mounting the fixture on a truss	4
Securing with a safety cable	5
DMX-512 connection/connection between fixtures	5
Power connection	6
Operation	6
Control Menu Map	6
Control menu.....	7
Main Menu.....	8
Addressing.....	8
Universal DMX Control.....	9
RDM control.....	9
Rotary Knob function	9
Set dimmer curves	10
DMX Protocol	11
Fixture Cleaning	11
Troubleshooting	12
The fixture does not work, no light.....	12
Technical specifications	12

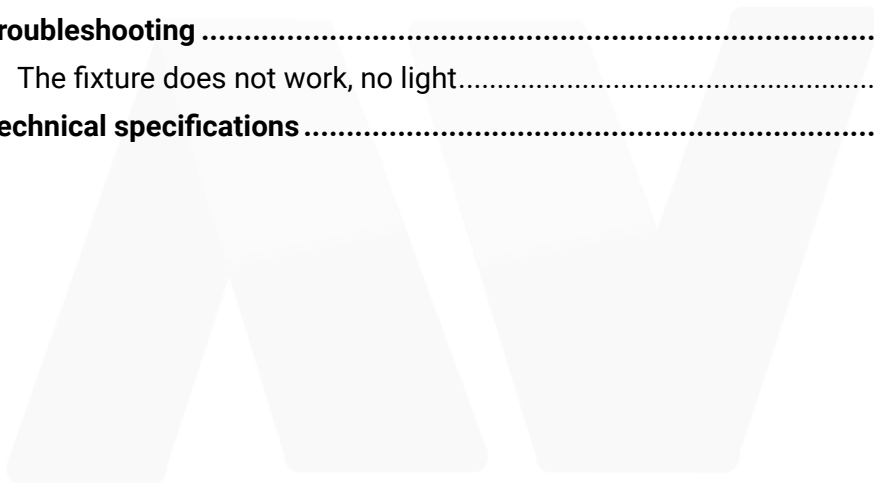



Caution!

 Be careful with your operations. With a dangerous voltage you can suffer a dangerous electric shock when touching the wires!

 Avoid looking directly into the light source!
 Wear protective glasses and other PPE (personal protective equipment) when working on or near the fixture.

Always make sure you are connecting this product to the proper voltage in accordance with the specifications in this manual or on the product's specification label. Make sure it is grounded when using it!

 Unplug mains lead before opening the housing!
 Make sure that the power cord is never crimped or damaged by sharp edges. Check the fixture and the powercord from time to time.
 Make sure to replace the fuse with another of the same type and rating.

 For your own safety, please read this user manual carefully before you initial start-up.
 Follow operating safety precautions and pay attention to warning signs methods and equipment on the user manual.

 Warning! This symbol indicates a hot surface. Certain parts of the housing can become hot during operation. After use, wait for a cool-down period of at least 10 minutes before handling or transporting the device.

 Indoor use only! To prevent risk of fire or shock, do not expose this product to rain or moisture.
 IP 20 rating.
 T =45°C The ambient temperature must always be between -5° C and +45° C.

- Every person involved with the installation, operation and maintenance of this device has to
- be qualified
 - follow the instructions of this manual
 - consider this manual to be part of the total product
 - keep this manual for the entire service life of the product
 - pass this manual on to every further owner or user of the product
 - download the latest version of the user manual from the Internet

Introduction

Thank you for having chosen PANEL150TW. You will see you acquired a powerful and versatile device.

Unpack your item. Before you initial start-up, please make sure that there is no damage caused by transportation. Should there be any, consult your dealer and do not use the device.

Safety instructions

This device has left our premises in absolutely perfect condition. In order to maintain this condition and to ensure a safe operation, it is absolutely necessary for the user to follow the safety instructions and warning notes written in this user manual. Always disconnect from the mains, when the device is not in

use or before cleaning it. Keep away children and amateurs from the device! There are no serviceable parts inside the device. Maintenance and service operations are only to be carried out by authorized dealers.

Installation

Read 'Safety information' before installing the fixture.

The fixture is designed for indoor use only and must be used in a dry location with adequate ventilation. Ensure that none of the fixture's ventilation slots are blocked.

Fasten the fixture to a secure structure or surface. Do not stand it on a surface or leave it where it can be moved or fall over. If you install the fixture in a location where it may cause injury or damage if it falls, secure it as directed in this user manual using a securely anchored safety cable that will hold the fixture if the primary fastening method fails.

Fastening the fixture to a flat surface

The fixture can be fastened to a hard, fixed, flat surface that is oriented at any angle. Ensure that the surface and all fasteners used can support at least 10 times the weight of all fixtures and equipment to be installed on it.

Fasten the fixture securely. Do not stand it on a surface or leave it where it can be moved or fall over. If you install the fixture in a location where it may cause injury or damage if it falls, secure it as directed below with a securely anchored safety cable that will hold the fixture if the primary fastening method fails.

Mounting the fixture on a truss

The fixture can be clamped to a truss or similar rigging structure in any orientation. When installing the fixture hanging vertically down, you can use an open-type clamp such as a G-clamp. When installing in any other orientation, you must use a half-coupler clamp that completely encircles the truss chord.

To clamp the fixture to a truss:

1. Check that the rigging structure can support at least 10 times the weight of all fixtures and equipment to be installed on it.
2. Block access under the work area.
3. Fold the legs of the mounting bracket together and bolt a rigging clamp securely to the mounting bracket. The bolt used must be M10, grade 8.8 steel minimum. It must pass through both mounting bracket legs and be fastened with a self-locking nut.
4. Working from a stable platform, hang the fixture with its clamp on the truss and fasten the clamp securely.
5. Secure the fixture with a safety cable as directed below.

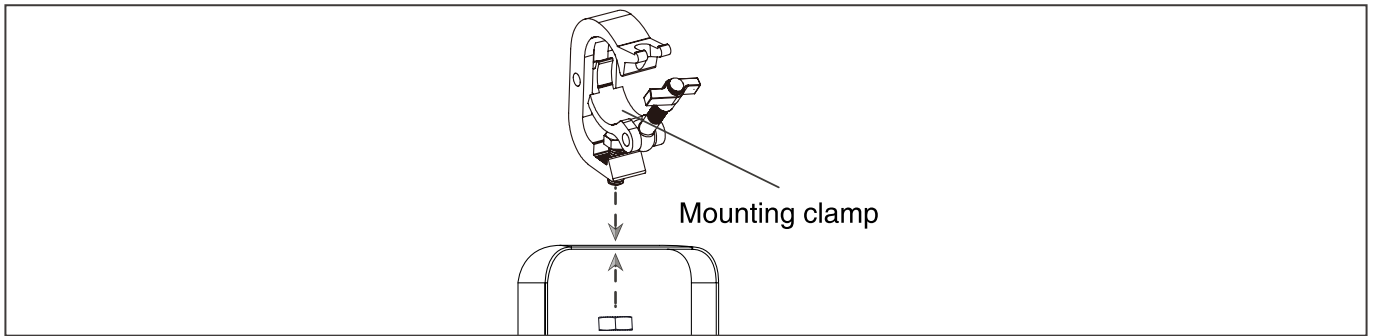

Securing with a safety cable

Secure the fixture with a safety cable (or other secondary attachment) that is approved for the weight of the fixture so that the safety cable will hold the fixture if a primary attachment fails.

Loop the safety cable through the eyebolt in the back of the fixture and around a secure anchoring point. Do not loop the safety cable around the fixture’s mounting bracket only, as this will leave the fixture unsecured if it separates from the bracket.

DMX-512 connection/connection between fixtures

Occupation of the XLR-connection:

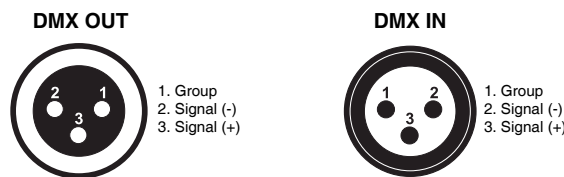

If you are using controllers with this occupation, you can connect the DMX-output of the controller directly with the DMX-input of the first fixture in the DMX-chain. If you wish to connect DMX-controllers with other XLR-outputs, you need to use adapter-cables.

Building a serial DMX-chain:

Connect the DMX-output of the first fixture in the DMX-chain with the DMX-input of the next fixture. Always connect one output with the input of the next fixture until all fixtures are connected.

DMX-512 connection with DMX terminator:

For installations where the DMX cable has to run a long distance or is in an electrically noisy environment, such as in a discotheque, it is recommended to use a DMX terminator. This helps in preventing corruption of the digital control signal by electrical noise. The DMX terminator is simply an XLR plug with a 120 resistor connected between pins 2 and 3, which is then plugged into the output XLR socket of the last fixture in the chain.

Caution: At the last fixture, the DMX-cable has to be terminated with a terminator. Solder a 120 Ω resistor between Signal (-) and Signal (+) into a 3-pin XLR-plug and plug it in the DMX-output of the last fixture.

Power connection

Power Requirements

The PANEL150TW luminaire operates on 100 to 240 volts AC (+/- 10%, auto-ranging). The luminaire contains an auto-ranging power supply.

Power linking between fixtures:

The fixture with powercon in and out socket. Connect the power out to the power in socket in the next fixture till all are connected.

Caution: maximum power linking - 6 units.

Connection with the mains:

Connect the device to the mains with the enclosed power supply cable.

The occupation of the connection cables as below:

Cable color	Connection	International
Brown	Live	L
Blue	Neutral	N
Yellow/green	Earth(Ground)	⊕

Operation

The PANEL150TW can operate in three different modes. This next section will detail the differences in the operating modes.

Control Menu Map

Default setting in **bold**.

MAIN MENU	LEVEL 1	LEVEL 2	LEVEL 3	FUNCTION INSTRUCTION
DMX	001-512			DMX address setting
Mode	DMX	2/5CH		DMX channel mode
	Auto	Program	001-004	Preset programs
		Speed	001-009	Programs speed
	Maunal	Dimmer	000-255	Dimmer 0-100%
CTO		3200K - 5600K	Color temperature 3200K - 5600K	
Dimmer	Curve	0.3-3.0		Dimmer curves adjustment
	Mode	Standard		Dimmer mode, Standard
		Stage		Dimmer mode, Stage
		TV		Dimmer mode, TV
		Architecture		Dimmer mode, Architecture
		Theatre		Dimmer mode, Theatre
		Studio		Less power, lower fan speed
		Turbo		Trubo mode, 300W output max.

		Custom	Fade in (150 ms~2230 ms) Fade out (150 ms~2230 ms)	Custom dimmer curve	
Advance	Authorization	On/Off		Advanced settings/calibration(Only qualified technicians should perform this function. Inquire your local dealer for password.)	
	Signal Priority	DMX		DMX signal priority setting	
	Signal Hold	On/Off		Run if signal cut	
	RDM	On/Off		RDM function on/off	
	Screen Timeout	30S			Display shut off time
		Never			
	Screen Brightness	25-100%			Display brightness
	Dimming Freq	1.20KHz			Dimmer frequency setting
		1.60KHz			
2.40KHz					
4.00KHz					
6.00KHz					
20.00KHz					
Software version		xxx		Software version	
Reset	Yes/No			System reset	
Reverse	Yes/No			Display reverse 180 degree	

Control menu

The information menu will appear after the fixture is switched on. In this menu, the following status is displayed:

The screenshot shows a blue control menu interface. At the top, 'DMX address' is indicated with a dashed line pointing to the large red number '001'. Below this, several status items are listed with dashed lines pointing to their respective values or indicators:

- Temp - 034°C/093F - LED temperature
- Signal Hold - On - Signal hold on/off
- Fan - 06 - Fan speed
- Mode - Custom - Dimmer curve
- Brightness 50% - Dimmer intensity (represented by a progress bar)
- CTO 3200K - Color temperature

Main Menu

Press the **MENU** button to enter the Main Menu interface.

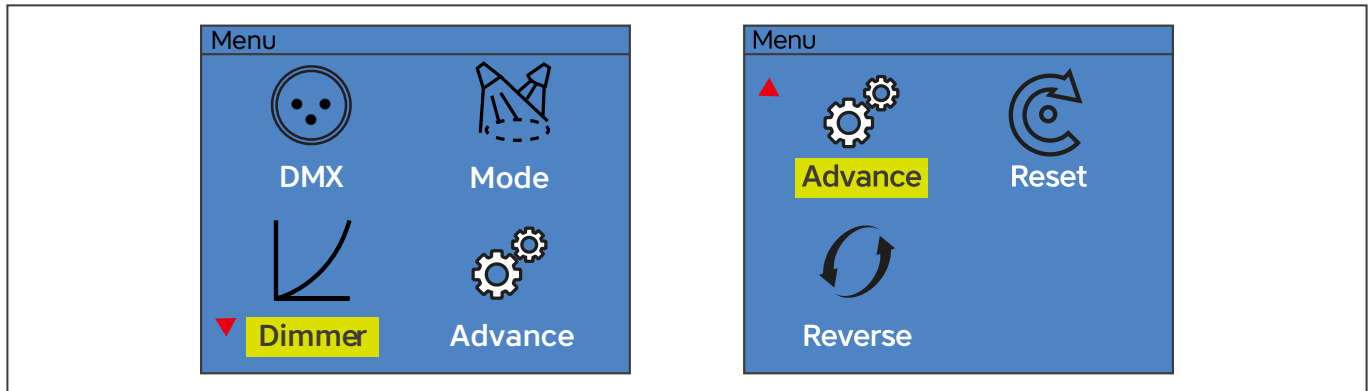

Addressing

All fixtures should be given a DMX starting address when using a DMX signal, so that the correct fixture responds to the correct control signals. This digital starting address is the channel number from which the fixture starts to listen to the digital control information sent out from the DMX controller. The allocation of this starting address is achieved by setting the correct number on the display located on the base of the device.

You can set the same starting address for all fixtures or a group of fixtures, or make different address for each fixture individually.

If you set the same address, all the units will start to listen to the same control signal from the same channel number. In other words, changing the settings of one channel will affect all the fixtures simultaneously.

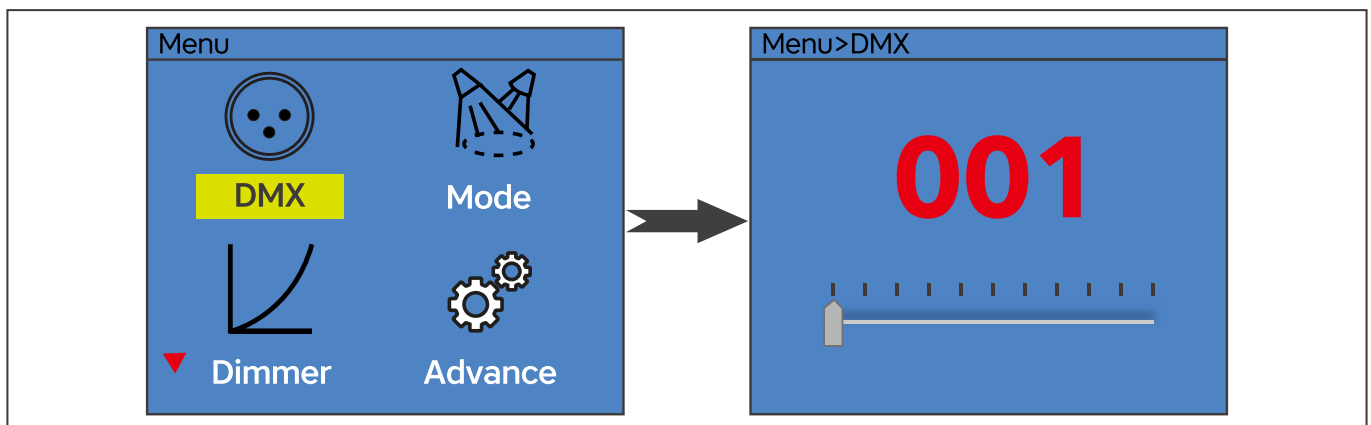

If you set a different address, each unit will start to listen to the channel number you have set, based on the quantity of control channels of the unit. That means changing the settings of one channel will affect only the selected fixture.

In the case of the PANEL150TW, which is 2/5 channels fixture. If you set, for example, the address in the 2 channel mode to channel 3, the device will use the channel 3-4 for control.

Note: After switching on, the device will automatically detect whether DMX 512 data is received or not. If there is data received at the DMX input, you will see the DMX indicator light in green.

Universal DMX Control

This function allows you to use a universal DMX-512 controller to control the dimmer and strobe. A DMX controller allows you to create unique programs tailored to your individual needs.

RDM control

The PANEL150TW can communicate using RDM (Remote Device Management) in accordance with ESTA’s American National Standard E1.20-2006: Entertainment Technology RDM Remote Device Management Over DMX512 Networks.

RDM is a bi-directional communications protocol for use in DMX512 control systems, it is the open standard for DMX512 device configuration and status monitoring.

The RDM protocol allows data packets to be inserted into a DMX512 data stream without affecting existing non-RDM equipment. It allows a console or dedicated RDM controller to send commands to and receive messages from specific fixtures.

With RDM function, you can set the DMX address of your fixtures remotely. This is especially useful when the device is installed in a remote area.

Each PANEL150TW has a factory set RDM UID (unique identification number).

Note: Before operation, enable RDM function in Advanced settings.

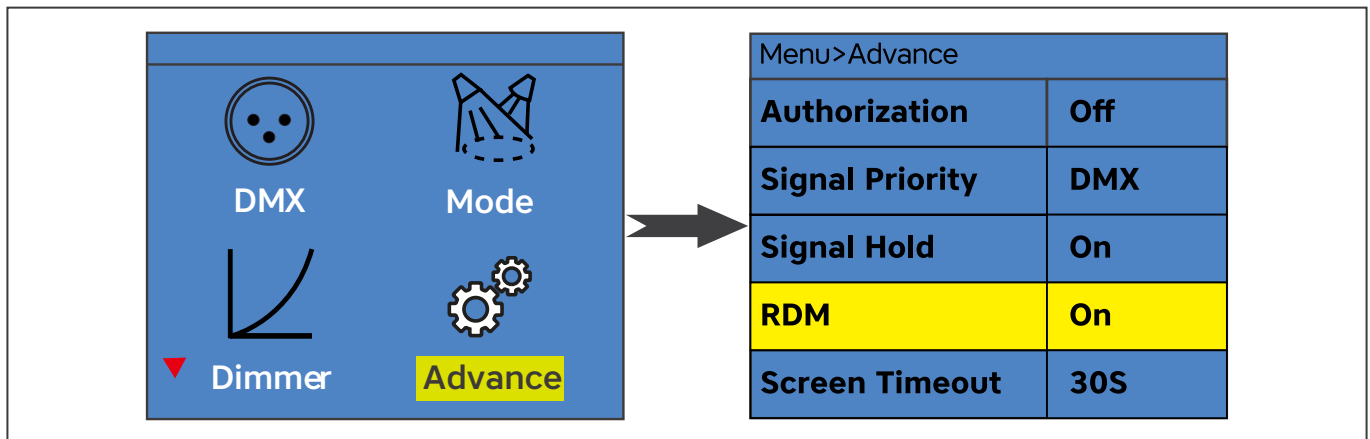

Rotary Knob function

The knob in the rear panel of the PANEL150TW act as multi function. Including rotary control of dimmer, rotary control of dimmer, up/down/enter function function.

Dimmer function:

1. Press the **MENU** button to enter the main menu.
2. Press the **UP** or **DOWN** button to select **Mode** menu and press **ENTER**.
3. Press **DOWN** menu and select **Manual** sub menu.

4. Press **ENTER** and select **Brightness** or **Strobe** in third menu.
5. Rotate the rotary knob to control the dimmer(right stop = maximum output, left stop = zero output), or strobe(right stop = maximum strobe, left stop = no strobe).

Note: Rotary dimmer or strobe function works in **information Menu** and **Mode-Manual** menu.

Up, Down, Enter function:

The knob can also act as up, down and enter function.

1. Press the **MENU** button to enter the main menu interface.
2. Right rotation = **Down**, left rotation = **Up**, press = **Enter** function.

Set dimmer curves

This function allows you to select preset dimmer curves as well as custom dimmer curves.

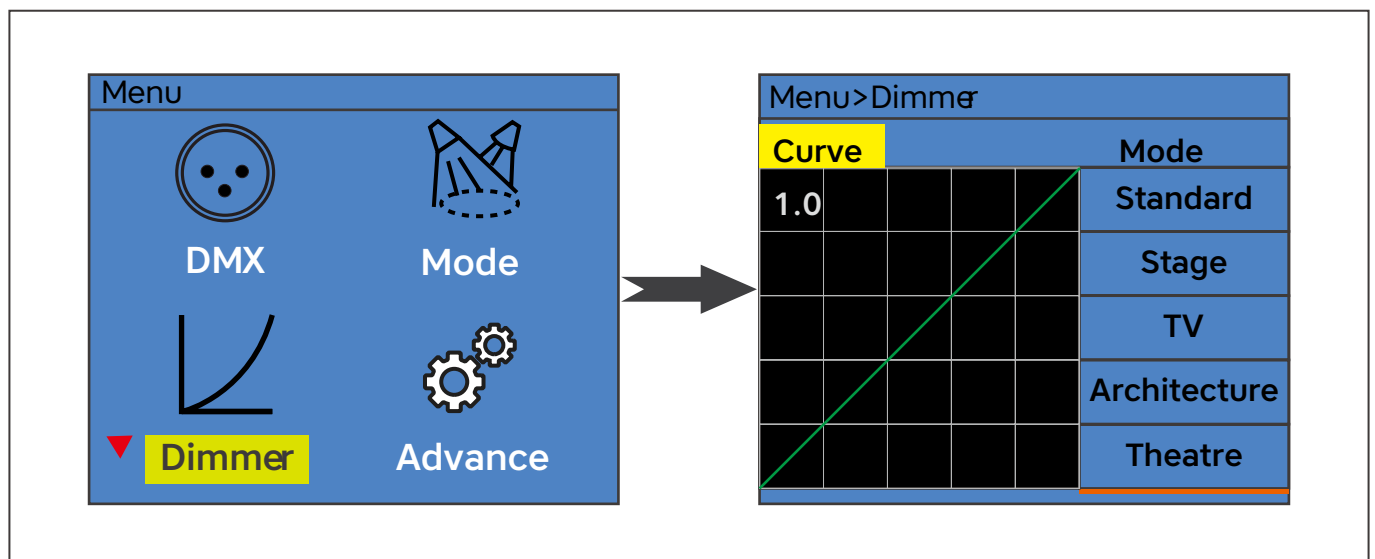

To set preset dimmer curves:

1. Press the **MENU** button to enter the main menu.
2. Press the **UP** or **DOWN** button to select **Dimmer** menu and press **ENTER**.
3. Press **DOWN** menu and select **Mode** sub menu.
4. Select disired dimmer mode.

Custom dimmer curves:

1. Press the **MENU** button to enter the main menu.
2. Press the **UP** or **DOWN** button to select **Dimmer** menu and press **ENTER**.
3. Press **DOWN** menu and select **Mode** sub menu.
4. Press the **UP** or **DOWN** button to select **Custom** menu and press **ENTER**.
5. Adjust fade in and fade out time to customize yout dimmer curves. Time vary from 150 ms to 2230 ms.

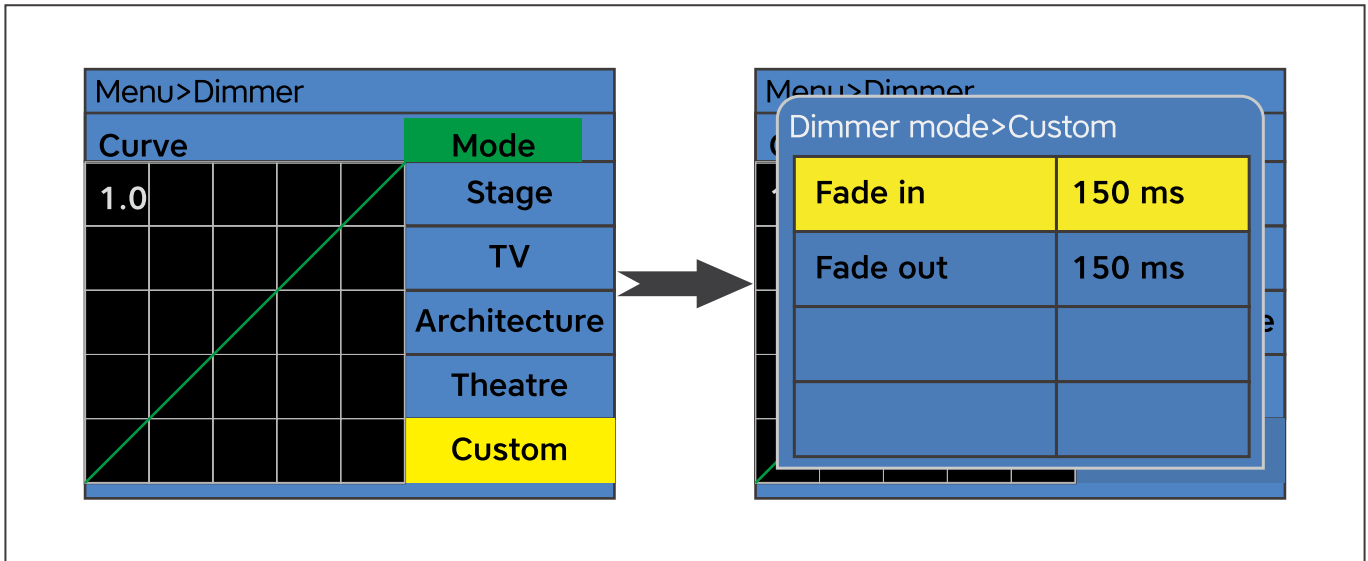

DMX Protocol

2 Channels Mode	Function	Function Control
CH1	WW	000-255: 0-100% dimmer
CH2	CW	000-255: 0-100% dimmer

5 Channels Mode	Function	Function Control
CH1	Dimmer	000-255: 0-100% dimmer
CH2	Strobe	000-255: from slow to fast
CH3	WW	000-255: 0-100% warm white dimmer
CH4	CW	000-255: 0-100% cold white dimmer
CH5	Color temperature	000-255: Color temperature 3200K - 5600K

Fixture Cleaning

Due to fog residue, smoke, and dust cleaning the internal and external optical lenses and mirror should be carried out periodically to optimize light output. Cleaning frequency depends on the environment in which the fixture operates (I.e. smoke, fog residue, dust, dew). In heavy club use we recommend cleaning on a monthly basis. Periodic cleaning will ensure longevity, and crisp output.

To clean the fixture:

1. Disconnect the fixture from power and allow it to cool for at least 10 minutes.
2. Vacuum or gently blow away dust and loose particles from the outside of the fixture with low-pressure compressed air.
3. Clean the surfaces by wiping gently with a soft, clean lint-free cloth moistened with a weak detergent solution. Do not rub glass surfaces hard: lift particles off with a soft repeated press. Dry with a soft, clean, lint-free cloth or low-pressure compressed air. Remove stuck particles with an unscented tissue or cotton swab moistened with glass cleaner or distilled water.
4. Check that the fixture is dry before reapplying power.

Troubleshooting

Listed below are a few common problems that you may encounter, with solutions.

The fixture does not work, no light

- Check the connection of power and main fuse. Be sure the external fuse has not blown.
- Measure the mains voltage on the main connector.

Technical specifications

Model	PANEL150TW
Power supply:	AC100-240V, 50/60Hz
Light source:	720 x 2 SMD LED
Power consumption:	150Watt max.
Color temperature:	3200K - 5600K tunable
Color Rendition:	CRI 95, TLCI 98
Power connection:	PowerCON in & out
Signal connection:	3-pin XLR in & out
DMX channels:	2, 5 CH
Control mode:	DMX, RDM, Rotary
Housing:	Colour black, aluminum
Size:	398 x 150 x 299 mm
N.W.(barndoor incl.):	5.5 kg
Accessories(included):	Power lead, Safety rope, Barndoor
Environment:	IP20

Please note: All information is subject to change without prior notice. 30.06.2021