

BATDOT20LIP

1×20W RGBW Battery Spot LED

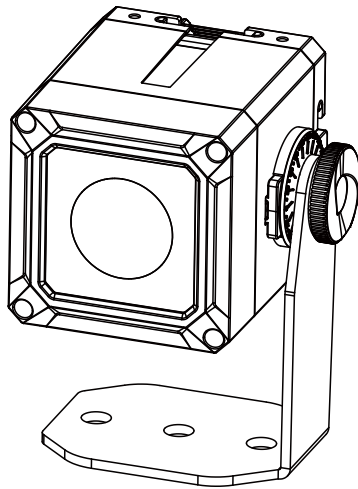

USER MANUAL

Packaging: Thanks for your purchasing the BATDOT20LIP. All the lights have been checked and are in excellent operating condition. Please check the shipping carton first, because there may be damage occurred during the shipment. Then check the lights carefully and be sure that the lights is intact and works normally. In the event damage has been found, spare parts are missing or the lights works abnormally, please contact us for further instructions. And please don't return the lights to the dealer before contacting us.

Introduction: The BATDOT20LIP is a mini wall washer with excellent performance. It is 200mm long, but its width of covering wall is 5m. 2.4G remote control is included. The house is made of extruded aluminum and die-cast aluminum cover. The ingress protection rating is IP65. However, there is no glue was used into the light. AB030 has won many certifications, including the CE, ROHS and so on.

SAFETY AND HANDLING

Before you operate this unit read the manual carefully. Always make sure to include the manual if you pass/rent/sell the unit to another user. Keep in mind that this manual cannot address all possible dangers and environments. Please use your own caution when operating. This product is for professional use only. It is not for household use.



- Do not operate the unit in areas of high temperature conditions. It will cause abnormal function or damage the product.
- Always use a suitable safety wire when mounting the light overhead.
- Connect the safety wire only to the intended safety mount.
- Always follow local safety requirements.



- Only qualified personnel may repair this product.
- Do not open the product housing.
- Do not apply power if the light is damaged.



- Do not directly look into the light.
- It can cause harm to your eyes.
- Do not look at the LEDs with a magnifying glass or any other optical instrument that may concentrate the light output.



- The exterior surfaces of the light can become hot, up to 70°C during normal operation.
- Ensure that accidental physical contact with the device is impossible.
- Install only in ventilated locations.
- Do not cover the light.



LI-ION Battery: A rechargeable lithium ion battery is built into this unit.

- Only authorized personal may service the battery.
- Do not place in fire or heat.
- Do not use or charge the light if it is damaged.
- Avoid bumping or plunging, it may cause fire or explosion.
- Never store the battery when fully drained.
- Always recharge immediately when empty.
- Make sure to fully charge all units before storing them.
- Partially charged batteries will lose capacity.
- The battery may only be replaced with an original spare part.



- Always charge with the flight case open.
- It is recommended to charge at a temperature between 15°C and 35°C



- The light contains a lithium ion battery.
- Don't throw the unit into the garbage at the end of its lifetime.
- Make sure to dispose is according to your local ordinances and/or regulations, to avoid polluting the environment!
- The packaging is recyclable and can be disposed.

Troubleshooting

The fixture does not turn on.

The battery may be empty. Connect it to the power cable and try again.

The fixture turns on and the display is on, but the LEDs do not emit light.

The fixture could be set to BLACKOUT mode, set to is DMX Hold and doesn't receive a valid signal. It is good practice to do a Factory Reset.

The fixture is not working correctly - it does not display the color or effect chosen.

The fixture may still be operating under a previous setting. It is good practice to do a Factory Reset.

After completing a RESET SETTINGS, the fixture still cannot be controlled.

Please turn off the light and turn on again,if cannot be controlled, too, please consult authorized personal.

The fixture does not run long enough on battery.

The required RUNTIME can be set. It defaults to several hours. To achieve a greater battery runtime, set the RUNTIME to the required value.

Alternatively, program the fixture to only display colors that use less power, such as Red, Green, Blue and White.

If the runtime is still too short, consider that it is reduced slightly if the battery is very cold.

The power cable is connected but the fixture is not charging.

The battery may be fully charged. Please read our user manual for more details. The fixture will only commence charging when its battery has a temperature of 45° or less. Turn the fixture off and let it cool down; once cold enough, it will start charging. If it still not charging, please consult authorized personal.

Features

- Led: 1*20W RGBW
- Lens:10°
- Magnetic frost filter:15,25,45,60,60*10 degree
- LED lifetime:50,000 hours
- Voltage:100 - 240V 50/60Hz
- Max power: 15W
- Cabled DMX: 5 pin XLR input/output
- Control: RDM, DMX 512 & Wireless DMX
- Color temperature: 2000K - 10000K
- CRI : ≥95
- Light output : 1000lm
- Lux: 34308 lux @ 2m
- DMX channels: 2/HSV/7/12/13/19CH
- Dimming:Electronic
- Strobe:0 – 25Hz
- Tilt:0 - 220°
- Power Supply Unit: Auto-ranging electronic switch-mode
- Color options: Black sand coat painting
- Cooling:Active, Forced Air, Temperature-regulated
- Temperature Range:-40°C to 45°C
- Thermal Protection: Automatic overtemperature protection
- Mounting point:2 x 2 quarter-turn locking points for one or two Omega brackets
- Safety features:Bottom mount for safety wire
- Display and Setting: OLED display / 4 buttons
- Waterproof: IP65
- Lens material: PE and tempered glass front
- Material: Aluminium
- Dimensions:100x 100 x 95 mm
- Net weight:1.2 kg

Programme Menu

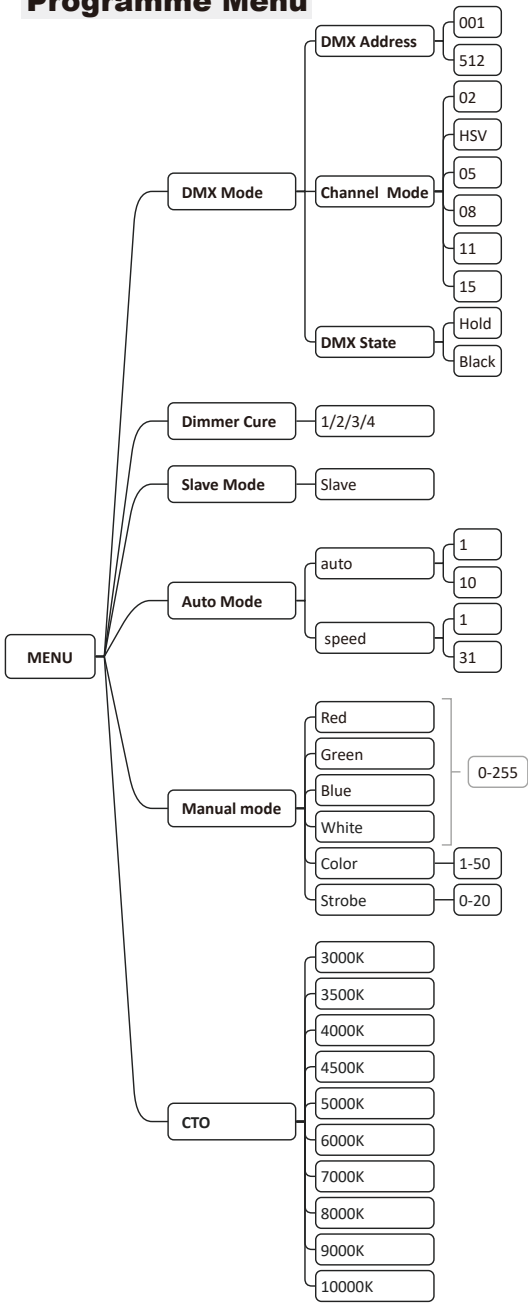

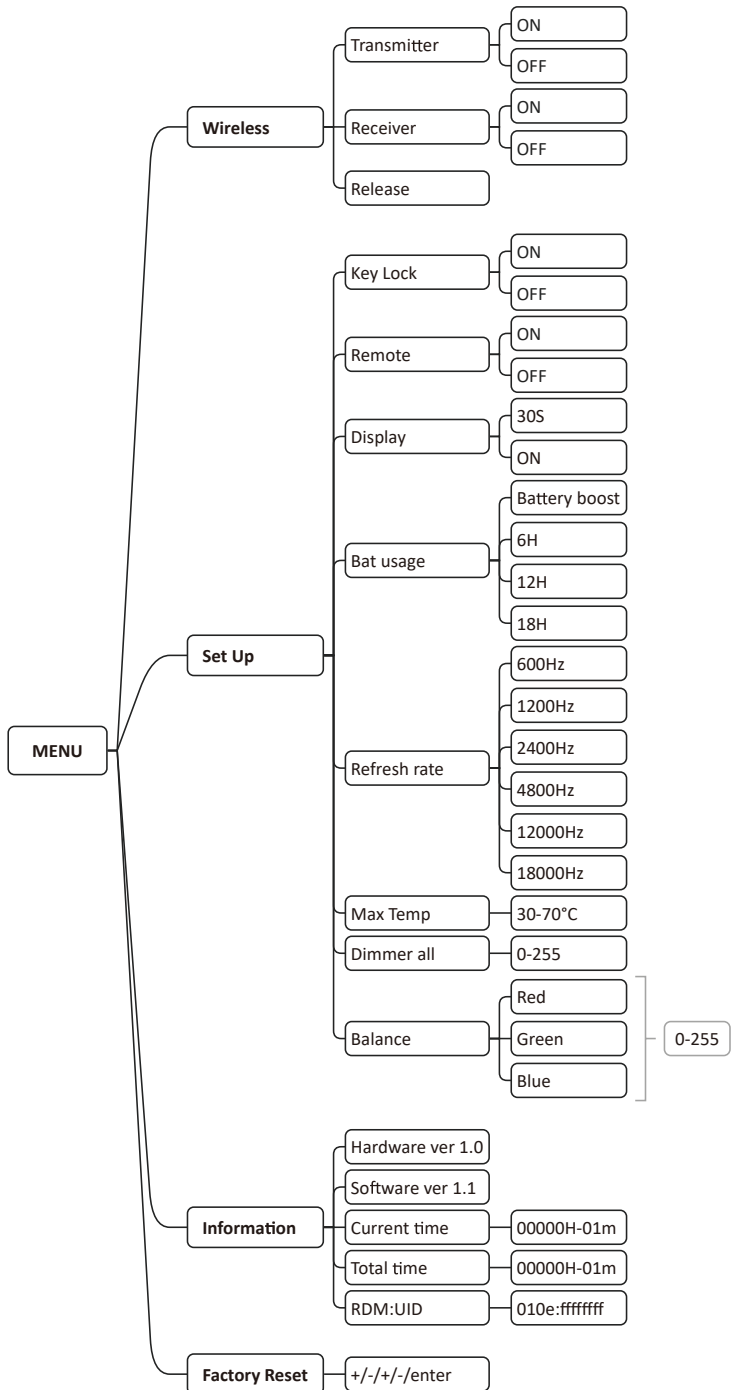

Displayer Introduction

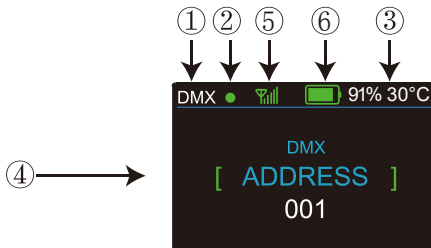

1. When you enter DMX Mode, it will be shown DMX, when you enter SLAVE Mode, it will be shown SLAVE.
2. This shows the condition of signal transmission. Green is connected. Red is disconnected.
3. This shows the temperature of the lights.
4. This shows the menus you can select.
5. This shows the condition of wireless signal. Green is connected. Red is disconnected.
6. This shows the battery's electric quantity.

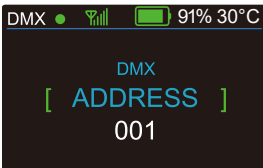

While DMX and Wireless signal are green, it means DMX Mode and Wireless are connected.

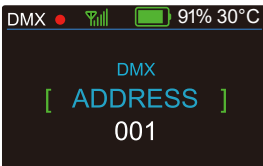

While DMX shows red but Wireless signal shows green, it means DMX Mode is disconnected and Wireless is connected.

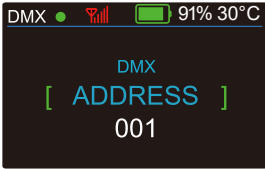

While DMX shows green but Wireless signal shows red, it means DMX Mode is connected and Wireless is disconnected.

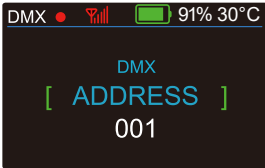

While DMX and Wireless are shown red, it means DMX Mode and Wireless are disconnected.

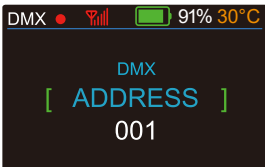

While the letters and number show change from white to yellow, it means the temperature is beyond the maximum temperature of default settings.

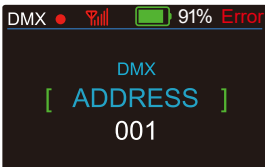

While the letters and number show Error, it means there are some temperature-related problems.

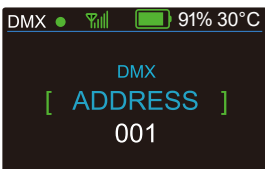

While the battery is charging, it will show running from empty to full. While you stop charging, it will show how much the electric quantity.

DMX-In this menu,you can connect several pieces of lights with DMX cable and control them with control console.

1. Press "ENTER" button and then UP or DOWN button until "DMX " is showed.
2. Press "ENTER" button, and "CHANNEL" or "ADDRESS" will be showed.Then press ENTER.
 - 1) "Channel [xx]" will be showed, "X" represents the showed DMX channel mode. You can press the UP or DOWN button to select your desired Channel mode.
 - 2) "xxx" will be showed, "x" represents the showed address. You can press the UP or DOWN button to select your desired address.

RUN MODE-In this menu, you can select DMX mode or SLAVE mode.In SLAVE mode,you can select one light as the MASTER light and other lights in SLAVE mode will run following the MASTER light.

1. Press "ENTER" button and then UP or DOWN button until "RUN MODE" is showed.
- 2.Press "ENTER" button, and"DMX" or "SLAVE" will be showed, then press ENTER to select your desired mode.

SET UP-In this menu, you can adjust the value of the function.

1. Press "ENTER" button and then UP or DOWN button until "SET UP" is showed.
2. Press "ENTER" button, and there will be nine options. Then,press ENTER to select the option and press UP or DOWN button to select the value you desire as below.
 - 1) ID number - You can select an ID Number in this menu.Then, you can adjust the value of channel 11 to the corresponding scope and control the light individually with control console.
 - 2) Display Led - In this item,you can select "ON" or "OFF".If you select ON,the displayer will be on all the time.And if you select OFF,the displayer will extinguish about ten seconds later.
 - 3) Key locks - You can select whether the password is on or off in this menu , and the password is [DOWN] + [UP] + [DOWN] + [UP] .If you select "on",then you have to input the password before pressing the buttons.Otherwise,the light won't respond to your order.
 - 4) Max temp - You can set the your desired Max working temperature about the light in this menu.When the working temperature of the light exceeds the Max temperature, the color of letter "Temp xx" showed in the menu will change from white to yellow.Meanwhile, the light will adjust the working temperature automatically.
 - 5) Dimmer RED - You can adjust the red brightness in this menu.
 - 6) Dimmer GREEN - You can adjust the green brightness in this menu.
 - 7) Dimmer BLUE - You can adjust the blue brightness in this menu.
 - 8) Dimmer WHITE - You can adjust the white brightness in this menu.
 - 9) Dimmer ALL - You can adjust the brightness of each color in this menu.

INFORMATION-In this menu, you can learn about the information of software, hardware and the working time of the light.

1. Press "ENTER" button and then UP or DOWN button until "INFORMATION" is showed.
2. Press "ENTER" button, and"Software" "Hardware" or "Fix times" will be showed. Then press ENTER, and you can see three items as below:
 - 1) Software - This item displays the Software information.
 - 2) Hardware - This item displays the Hardware information.
 - 3) Fix times - This item displays the working hours about the light.

AUTO-In this menu, you can select your desire AUTO mode and adjust the running speed.

1. Press "ENTER" button and then UP or DOWN button until "AUTO" is showed.

2. Press "ENTER" button, and "SPEED" or "PROGMA MODE" will be showed. Then press ENTER, and you can see two items as below:

- 1) SPEED - You can select your desired speed in this menu.
- 2) PROGMA MODE - You can select your desired auto mode in this menu.

CUSTOM MODE-In this menu, you can select the AUTO program edited in the "EDIT" menu.

1. Press "ENTER" button and then UP or DOWN button until "CUSTOM MODE" is showed.
2. Press "ENTER" button, and there are 11 pre-programmed mode edited in the "EDIT" menu.

CAL WHITE-In this menu, you can adjust the value of 11 different white color.

1. Press "ENTER" button and then UP or DOWN button until "CAL WHITE" is showed.
2. Press "ENTER" button, and there are 11 pre-programmed White colors that can be edited by adjusting the value of "Red", "Green", "Blue" and "White".

STAT COLOR-In this menu, you can adjust the value of static color and strobe speed as you like.

1. Press "ENTER" button and then UP or DOWN button until "STAT COLOR" is showed.
2. Press "ENTER" button, and there are six options. Then press ENTER to select the option and press UP or DOWN button to select the value you desire as below:
 - 1) STAT RED - You can adjust the red brightness in this menu.
 - 2) STAT GREEN - You can adjust the green brightness in this menu.
 - 3) STAT BLUE - You can adjust the blue brightness in this menu.
 - 4) STAT WHITE - You can adjust the white brightness in this menu.
 - 5) STAT AMB - You can adjust the amber brightness in this menu.
 - 6) STAT UV - You can adjust the purple brightness in this menu.
 - 7) SELET COLOR -You can select 52 static color in this menu.
 - 8) STAT STROB - You can adjust the strobe speed in this menu.

EDIT-In this menu, you can edit your desired AUTO program.

1. Press "ENTER" button and then UP or DOWN button until "EDIT" is showed.
2. Press "ENTER" button, and open the "EDIT" mode to edit the custom programs from "PR.01" to "PR.11". And there are 21 scenes that can be edited in each custom program.
3. You can edit a scene by adjusting the value of "RED (0~255)", "GREEN (0~255)", "BLUE (0~255)", "WHITE (0~255)", "AMBER (0~255)", "PURPLE (0~255)", "FADE (0~31)", "FLASH(0~50)", "STROBE (0~31)" & "TIME (0~100)" as you like . Then the data will be saved, when you press the ENTER button for 5 seconds.

UPLOAD-In this menu, you can connect several pieces of lights with MAX cables and set one light as the MASTER and others in SLAVE mode. Then upload the custom program in the MASTER light to the lights in SLAVE mode.

1. Press "ENTER" button and then UP or DOWN button until "UPLOAD" is showed.
2. Press "ENTER" button to upload the custom programs from the MASTER light to the SLAVE ones.

RESET-In this menu, you can reset all the value of the system.

1. Press "ENTER" button and then UP or DOWN button until "RESET" is showed.
2. Press the ENTER button to reset all the value of the system.

DMX control mode

2 CHANNELS		
Channel	Value	Function
1	000-255	Color 1-color 51
2	000-255	White color marco: 3000K-10000K

3 CHANNELS		
Channel	Value	Function
1	000-255	Hue
2	000-255	Saturation
3	000-255	Value (brightness)

5 CHANNELS		
Channel	Value	Function
1	000 - 255	Red
2	000 - 255	Green
3	000 - 255	Blue
4	000 - 255	White
5	000 - 255	Strobe (slow -fast) 25次/s

8 CHANNELS		
Channel	Value	Function
1	000 - 255	Master dimmer
2	000 - 255	Red
3	000 - 255	Green
4	000 - 255	Blue
5	000 - 255	White
6	000 - 255	Color 1-color 51
7	000 - 255	White color marco: 3000K-10000K
8	000 - 255	Strobe (slow -fast) 25次/s

11 CHANNELS		
Channel	Value	Function
1	000 - 255	Master dimmer
2	000 - 255	Red
3	000 - 255	Green
4	000 - 255	Blue
5	000 - 255	White
6	000 - 255	Color 1-color 51
7	000 - 255	White color marco: 3000K-10000K
8	000 - 255	Strobe (slow -fast) 25次/s
9	000 - 255	Auto 1-12
10	000 - 255	Auto speed
11	000 - 009	No function
	010 - 029	Dimmer Speed1(fast)
	030- 069	Dimmer Speed2
	070 - 129	Dimmer Speed3
	130 - 189	Dimmer Speed4
	190 - 255	Dimmer Speed5(slow)

15 CHANNELS		
Channel	Value	Function
1	000 - 255	Master dimmer
2	000 - 255	Red
3	000 - 255	Red fine
4	000 - 255	Green
5	000 - 255	Green fine
6	000 - 255	Blue
7	000 - 255	Blue fine
8	000 - 255	White
9	000 - 255	White fine
10	000 - 255	Color 1-color 51
11	000 - 255	White color marco: 3000K-10000K
12	000 - 255	Strobe (slow -fast) 25次/s
13	000 - 255	Auto 1-12
14	000 - 255	Auto speed
15	000 - 009	No function
	010 - 029	Dimmer Speed1(fast)
	030- 069	Dimmer Speed2
	070 - 129	Dimmer Speed3
	130 - 189	Dimmer Speed4
	190 - 255	Dimmer Speed5(slow)

Mounting

When installing the unit, the trussing or area of installation must be able to hold 10 times the weight without any deformation. When installing the unit must be secured with a secondary safety attachment, e.g. and appropriate safety cable. Never stand directly below the unit when mounting, removing, or servicing the unit.

Overhead mounting requires extensive experience, including calculating working load limits, installation material being used, and periodic safety inspection of all installation material and unit. If you lack these qualifications, do not attempt the installation yourself.

The installation should be checked by a skilled person once a year.

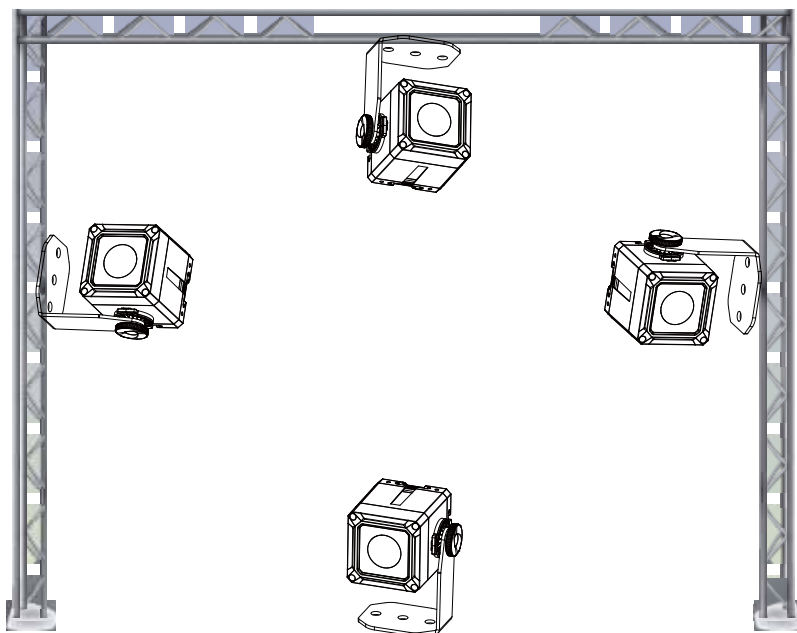

The BATDOT20LIP is fully operational in two different mounting positions, hanging upside-down from a ceiling or set on a flat level surface. To avoid internal damage to the unit, never mount the unit on its side as illustrated above. Be sure this fixture is kept at least 0.5m away from any flammable materials (decoration etc.). And you'd better use and install the supplied safety cable as a safety measure to prevent accidental damage and/or injury in the event the clamp fails (see next page).

Product Overview

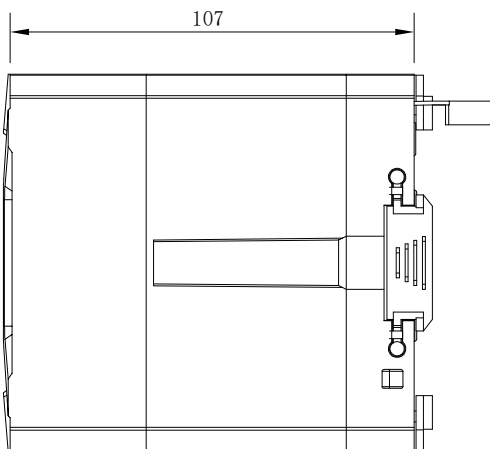
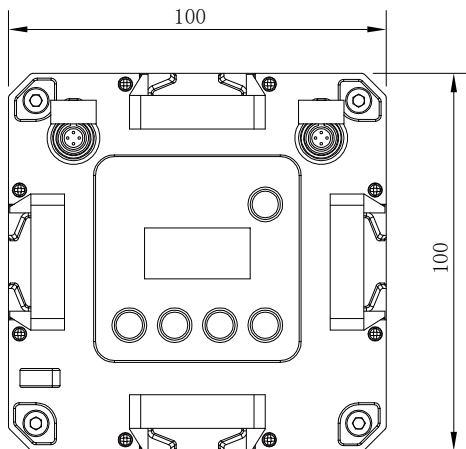

CHARGE WITH ABS CASE



DURING THE COMPLETE PROCESS OF BATTERIES CHARGE THE UPPER COVER OF THE FLIGHTCASE MUST BE ALWAYS OPEN.



DURING THE COMPLETE PROCESS OF BATTERIES CHARGE THE PROJECTORS MUST BE ALWAYS OFF.

For correct use of the battery it is strongly recommended to:

- Charge the battery at least one time each month
- The minimum level of the charge must be not less than 5%

During the charge, the battery icon (visible on the display) will show the level of the charge. When the charge is finished, the icon will be totally green.

Connection in wireless mode - Master/Slave



When connection wireless mode, please remember release first.



Master
-Transmitter mode

Slave
-Receiver

Wireless indicator status	Description
Both blinking red color	wireless transmitter or receiver OFF or not linked with the projector
Both blinking but: Wireless green	Master and Slave with the projector not connect success
Both fixed green color	Master-Transmitter mode ON and linked with the projector projector Slave- Receiver

Connection in wireless mode -DMX



When connection wireless mode, please remember release first.

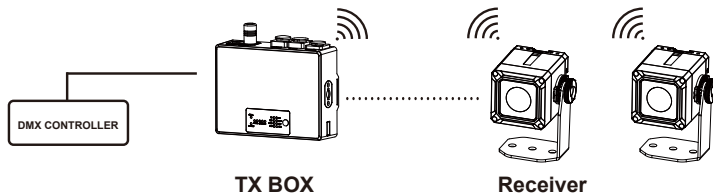

DMX led status and wireless indicator	Description
Both blinking red color	DMX not connected e wireless transmitter OFF or not linked with the projector
Both blinking but: DMX red - Wireless green	DMX not connected,transmitter ON and linked with the projector
Both fixed green color	Dmx connected,transmitter ON and linked with the projector





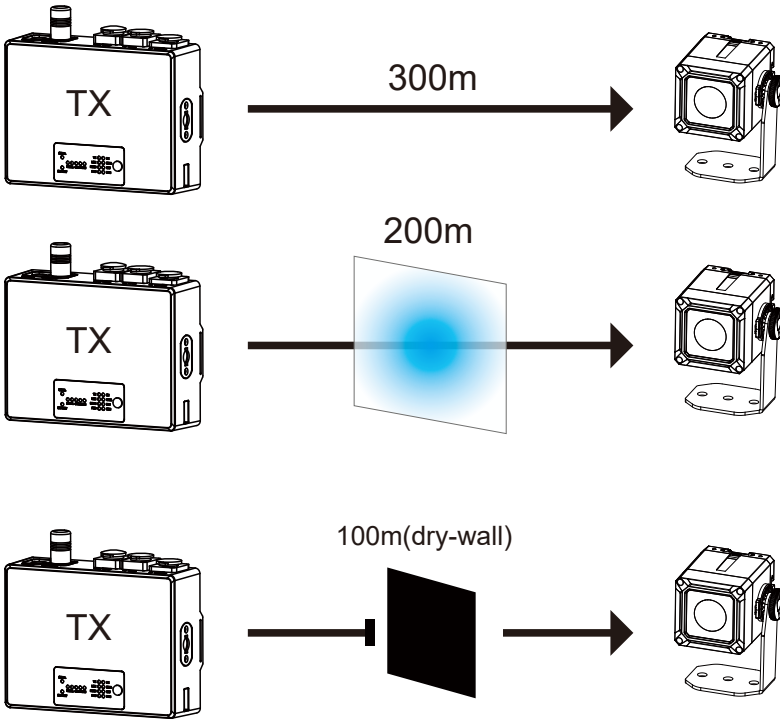

Tips & tricks

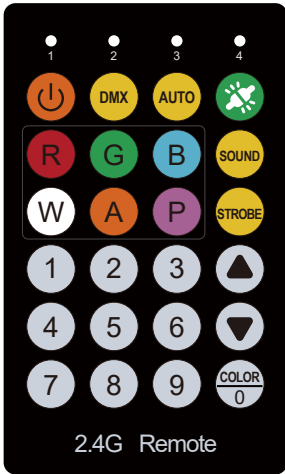

There are limitations to how wireless waves propagate through air. Physical barriers like glass, concrete and walls will limit the transmission range. Always try to have clear line-of-sight between transmitters and receivers.



2.4G Remote



-  Power on/off button
Press and hold the power button for 3 seconds to turn on/off the remote control , short press the control light switch
-  DMX button,to control DMX address when press this button.It is SLAVE mode when double click.
-  AUTO The first one is Auto Mode.It is Speed mode when double click.
-  SOUND The first one is Sound Mode.It is Speed mode when double click.
-  Strobe mode button
-  Up and down button,you can choose the program that you need or numerical.
-  Switching group button
Press and hold the button for 5 seconds to enter matching mode

    Group indicator light  Press color button enter color menu

      Color choosing button.

         

You can use these number button to adjust numerical in any program mode.

How to connect 2.4G remote control

1. Press and hold the  button for 3 seconds to turn on or off the power of the remote control (the indicator light indicates that the remote control is turned on, and the remote control power will be automatically turned off after 1 minute of no operation).

!!The indicator light will automatically turn off after 1 minute of use and need to be pressed again for 3 seconds to turn on again.

2.Press and hold the  button for 5 seconds, the indicator blinks, enters the matching mode, and automatically exits the pair mode after 20 seconds.

3.Turn on the light and enter [SETUP]→[REMOTE]→[ON], press the [ENTER] key to enter the matching mode. (If [ON] is displayed in the [REMOTE] mode during startup, you need to press the [ENTER] key again to enter the matching mode.)

4. During the flashing of the remote control light, the lamp flashes 3 times, which means that the connection is successful.
5. After the match is successful, when the remote control light is on, it means that the group of lamps is being controlled.
6. If there are multiple lamps that need to be connected, please repeat the above steps and press the  button to select different groups for connection. (Each group can connect up to 50 lamps.)
7. The furthest remote control distance of this product is about 50 meters. No need to rematch after power failure.